

产品平面图

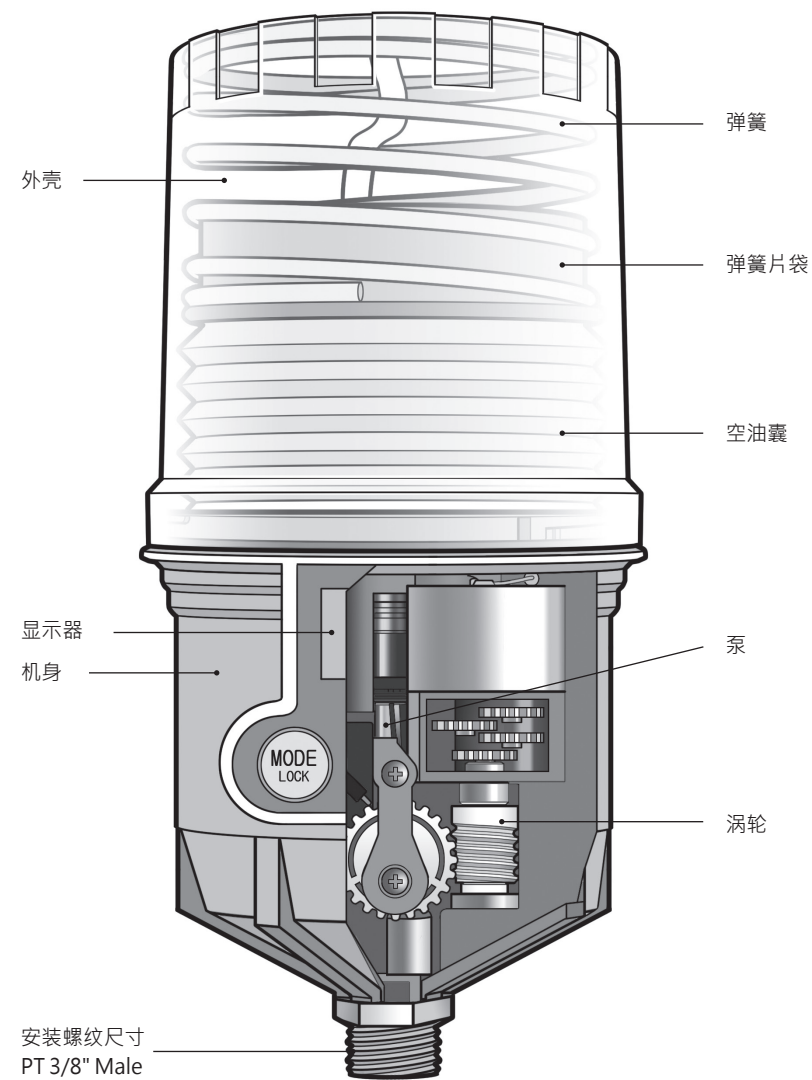

安装方法

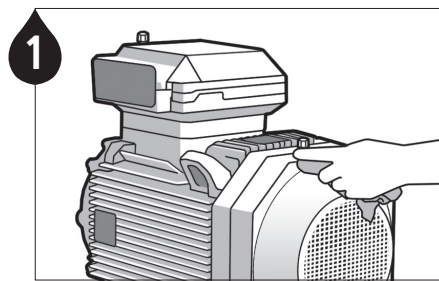

1 擦干油脂嘴周边的污垢

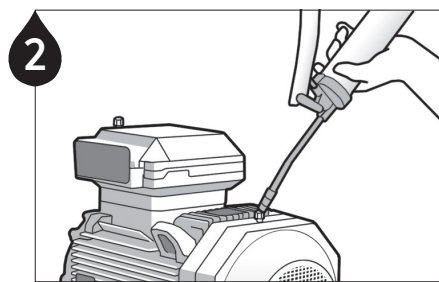

2 如管路被堵请用黄油枪打通管路
Note1 如油脂硬化请用黄油枪清除 (Purging) 硬化油 **Note2** 油脂需要与目前使用的油脂相同或具有相容性

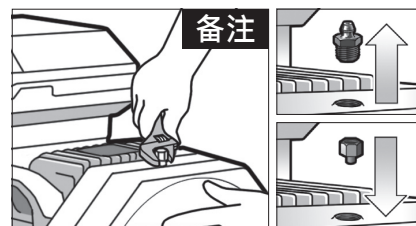

3 拧开油脂嘴 (Nipple) 接合相应变径接头



4 确认专用备件包容量及其构成品 (电池盒, 空油囊, 防尘罩, 标贴)

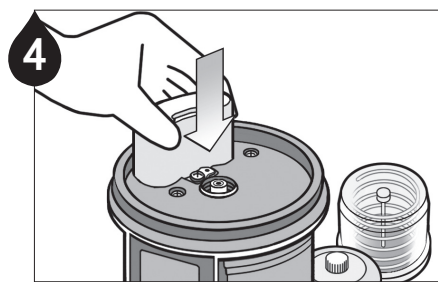

5 插入电池



6 从油包挤出少量油脂后接合至产品

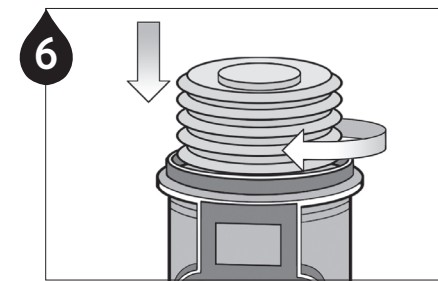

7 请轻轻接合油包

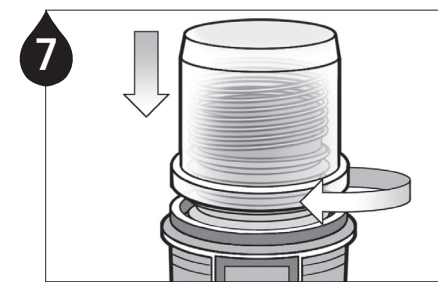

8 接合外壳

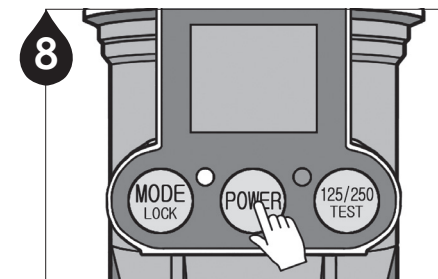

9 长按2秒开启电源

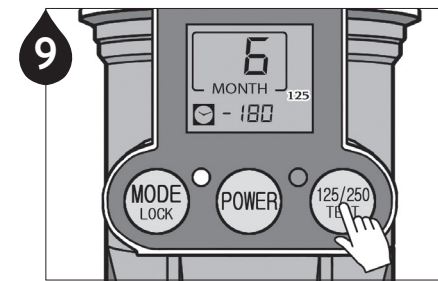

10 根据油囊容量设定容量 (125ml 或 250ml)

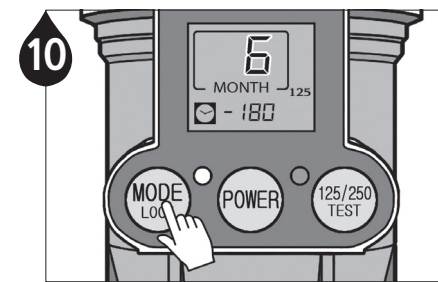

11 设定喷脂周期

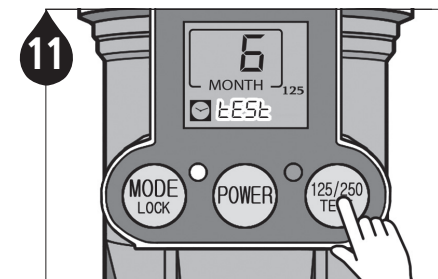

12 长按2秒TEST按钮确认是否正常喷脂

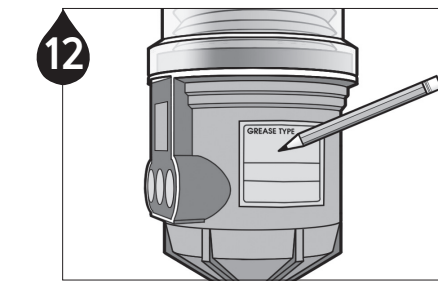

13 将产品安装至设备的润滑点上, 如当前喷脂周期已满请更换专用备件包 (No 3~7)

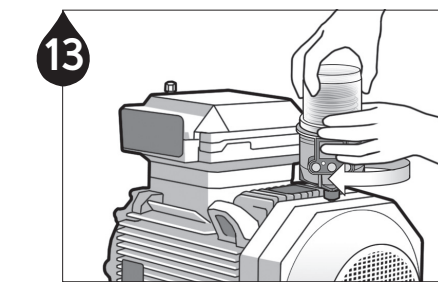

14 请盖上防尘罩

错误处理

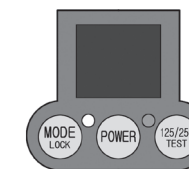

状态: LCD显示器异常 (部分显示器变色)
 原因: 中央处理器或显示器异常
 修复: 按初始化设定 (RESET) 后如反复出现同样问题请联系代理商

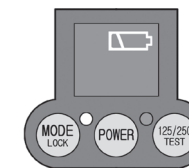

状态: 电池电压不足
 原因: 使用环境恶劣 (潮湿, 低/高温, 高负荷) 的情况下电池消耗量会增大
 修复: 请在适当环境使用本产品/如不得不在恶劣环境使用请使用锂电池组 (单独售卖)

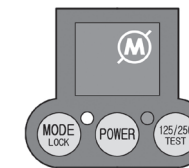

状态: 背压过高导致停止喷脂
 原因: 连接管折弯或轴承管路被堵
 修复: 确认负荷程度/缩短连接管长度/去除润滑点污垢

按键功能

MODE LOCK

供油周期选择
125/250ml: 1, 2, 3, 6, 12个月 & 15日 (H)

自动关机解除
长按2秒 () 解除

POWER

电源 ON/OFF
ON: 长按2秒
OFF: 长按3秒

125/250 TEST

125ml, 250ml 容量选择
-按1次后依照顺序变更
*仅适用于EX250
TEST操作性能
-操作性能: 长按2秒
-解除: 轻按一次 (相关步骤结束后停止)

LCD显示器



设定供油周期

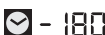

设定周期剩余日数



关机标识



125/250

设定油脂容量



清除强制注油



设定周期结束后经过日数
  同时标识

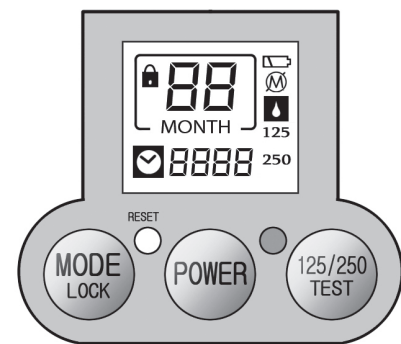

RESET 原设定初始化



供油中断后经过日数
 检查标识



电量不足



供油中断标识



油脂不足



错误 (电量不足, 供油中断) 及注油完成时灯灭

ISO9001/14001 CE

产品认证



Ex nL IIB T5



Ex nL IIB T5 IP54
12-KB2BO-0279X



US 6.354.816
6.498.956
EP1 104 867



Pulsarlube EX为获得 ATEX (欧洲) 以及 KCs (韩国) 防爆认证的产品。

产品安装

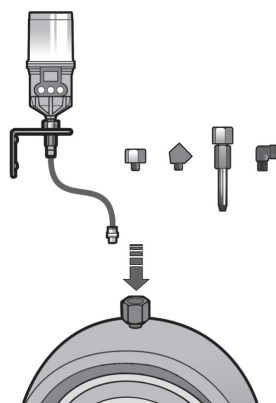

单点润滑

直接安装或利用连接管远程安装

一般情况下建议直接安装, 如安装空间不足可以用相应配件进行远程安装, 连接管长度请保持最短。

使用连接管进行远程安装时, 请预填充与加脂器同类的油脂并使用外径6mm以上连接管。



警告

爆炸危险-请勿在电源连接或存在可燃烧蒸汽/气体的环境下更换或拆卸电池。

- ▶ 请勿在电源连接的状态下打开产品
- ▶ 请勿使用可充电电池
- ▶ 请勿对产品造成冲击

Reference Designation	Description	Type of Protection
M1 SW4	Motor Reed Switch	Non-incendive Circuit Non-incendive Circuit

质保期

每个自动加脂器的质保期为一年。
产品质保仅限于材料以及工艺的原始缺陷, 不包括任何由于误操作, 滥用以及任何其他不合理使用该产品而产生的附带损害。

Rev.04

PULSARLUBE

The World Leader of Automatic Lubrication



楷迅(上海)润滑科技有限公司

上海市闵行区吴宝路255号力国大厦2楼218室

电话: +86 21-6221-8211 传真: +86 21-6221-9020

网站: www.pulsarlube-cn.com 邮箱: sales.china@pulsarlube.com

PULSARLUBE

产品说明书

Pulsarlube EX

Series

(125&250ml)

